

MCU

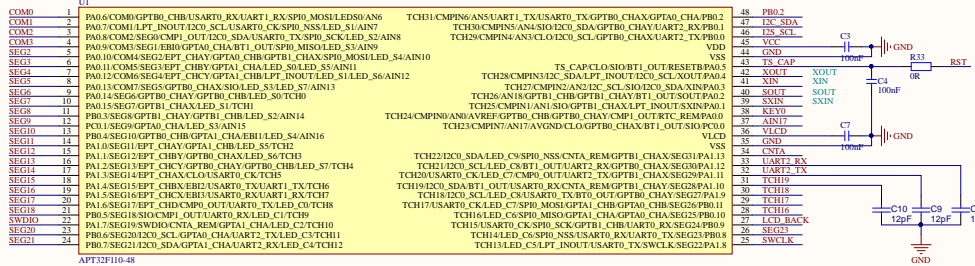

UART: UART->USB

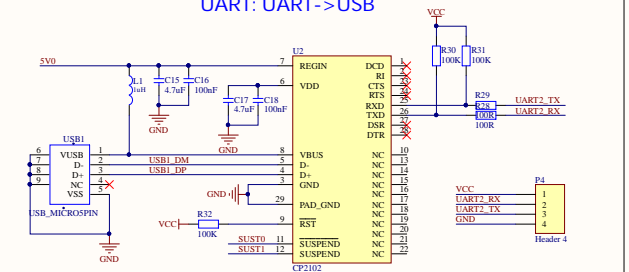

系统供电

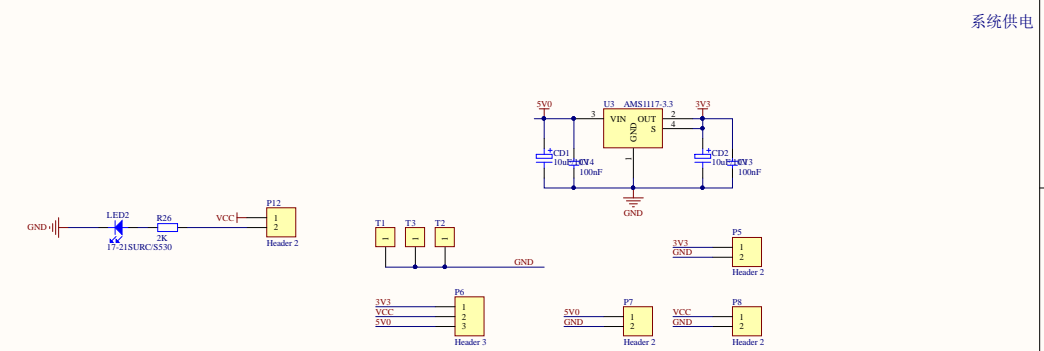

数字温度传感器

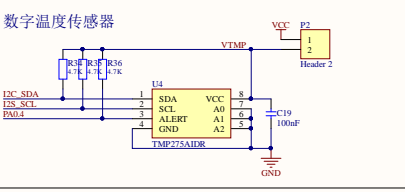

电压采集

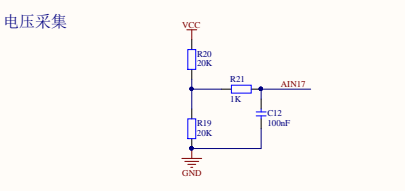

LCD

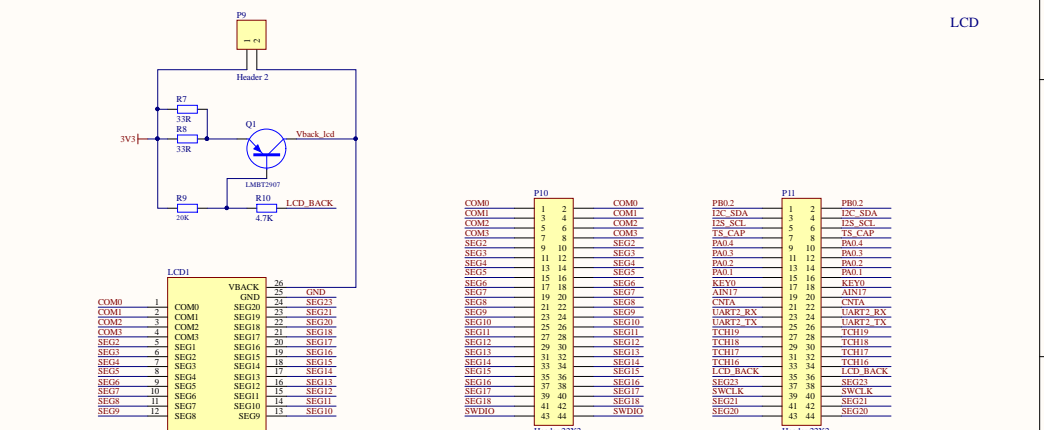

唤醒按键

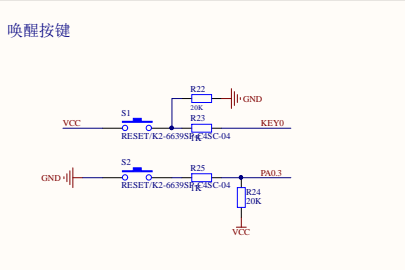

复位/设置按键

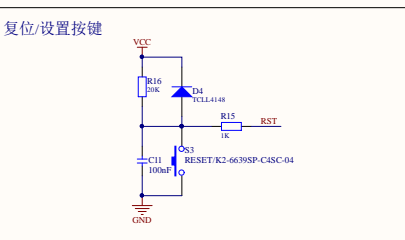

TOUCH

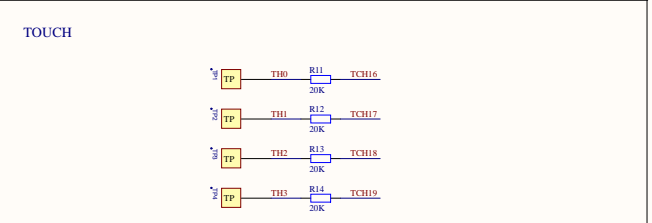

轰鸣器

